

Flat Roof Solar Mount System

2022 Version2

- Premium materials
- Precision without cutting
- Pre-assembled & height adjustable
- Full warranties & first-class service
- All improved & patented

Content

ATV System	1-2
APAT System	3-4
PAT System	5-6
ECO N&S System	7-8
ECO W/E System	9-10
Arch 5.10 System	11-12
Arch 5.20 System	13-14
Arch 5.30 System	15-16



Manufacturing facilities for both aluminum and steel products



Experienced team since 2010



Global service



Direct racking supply



Design standard:
AS1170.2:2011,
JIS C 8955:2011,
UL 1703/2703



10 Years warranty

About us

WOCHN Green Energy Co.,Ltd

WOCHN Energy is a high-tech company which specializes in designing, manufacturing, selling solar mounting system. Headquartered in Shanghai, WOCHN has invested two factories in Xiamen & Zhejiang. WOCHN built partnerships with 5 main distributors overseas and keep expanding its sale network worldwide.

WOCHN's products and services have become synonymous with quality and innovation, delivering a wide range of solutions to the industry, its professional and friendly service is globally renowned by customers.

WOCHN offering innovative design and integrative settlement solution to our customers based on years of experiences on design, production and sale. We achieved good trust from customers because of our stable and excellent products. We will try our best to become a world leading level of solar photovoltaic systems integration solutions supplier.

WOCHN is committed to locally delivering a wide range of products and services: local distributor investigating at site, delivering goods soonest, offering the best after-sales service. Our customers count on us before, during and after the installation. You can rest assured that when you partner with WOCHN you've made the right decision.



ATV System

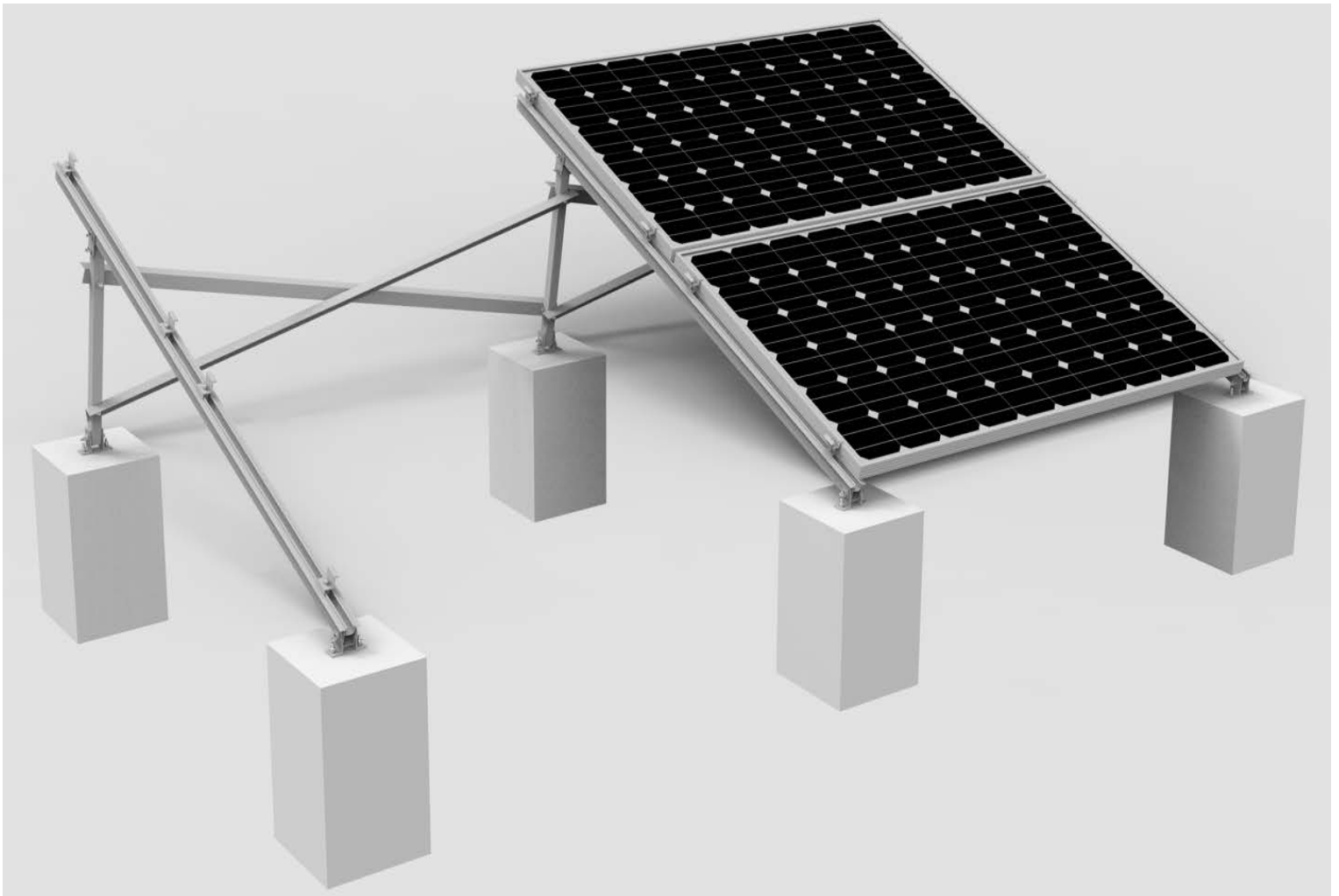

Components



ATV Leg



Expand Bolt



Mid Clamp



End Clamp

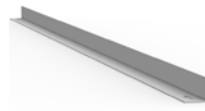

Strengeh Kit J35

Advantage

- Unique beam designed, one beam for place modules on two side
- Pre-assembled ATV legs for easy and quick to install
- Adjustable tilt angle from 10 to 30 degree, flexibility for different inclination
- Flexibility for long or short rows arrays
- Flexibility for 1/2/3/4 panles landscape arrays

Unique Feature



· Easy to place solar modules on the ATV leg beams' two side. Longer module arrays placed, price more cost-effective.

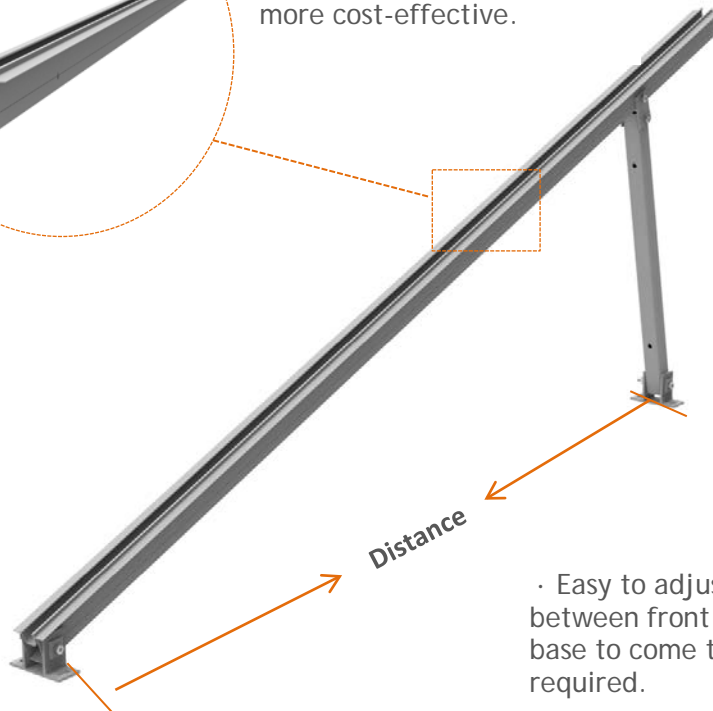

Distance

· Easy to adjust the distance between front base and back base to come to the inclination required.

- Item No.:WQ-ATV-1030
- Angle Adjustable Range : 10 to 30 deg
- Workable for modules:
 - Length : 1960 to 2400 mm
 - Width: 900 to 1200 mm
 - Thickness: 30 to 40 mm

Technical Data

Product name	ATV Mount System
Application	Flat concrete roof
Inclination	Standard or customized
Material	Aluminum 6005 T5
Finish	Anodized clear, average 12um
PV module	Framed
Module size	Small and Big modules
Module orientation	2/3/4 modules landscape
Module direction	South , North

APAT System

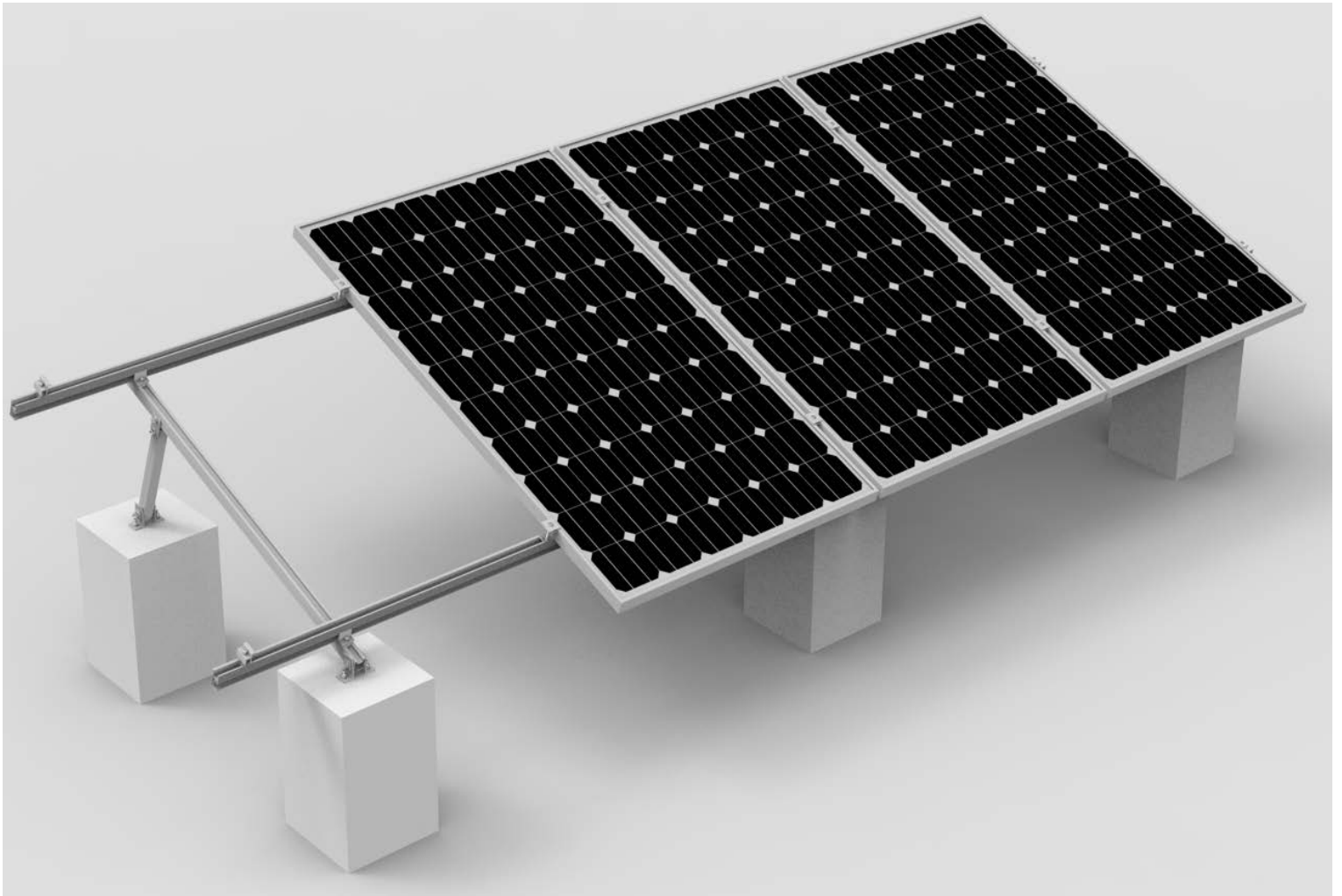

Components

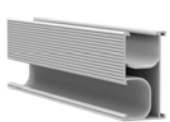

5L Rail



Rail Splice



Mid Clamp



End Clamp



Rail Fix Kit



Expand Bolt



APAT Leg

Advantage

- Adjustable tilt angle from 10 to 30 degree, flexibility for different inclination
- Pre-assembled APAT legs for easy and quick to install
- Ballasted with concrete foundation or directly use on flat concrete roof
- Universal mid and end clamp for 30 to 40 mm thickness modules
- Flexibility for long or short rows arrays

Unique Feature

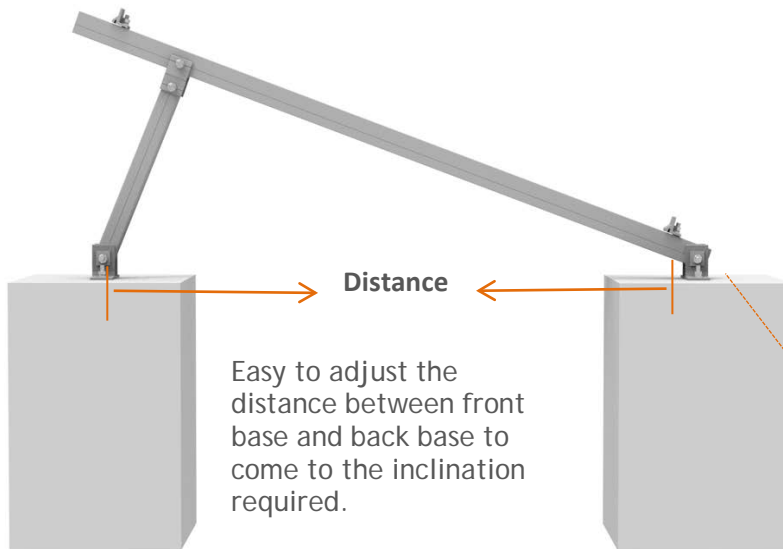

- Item No.: WQ-APAT-1030
- Angle Adjustable Range : 10 to 30 deg
- Workable for modules:
 - Length : 1960 to 2400 mm
 - Width: 900 to 1200 mm
 - Thickness: 30 to 40 mm

Customized inclination is workable !

Technical Data

Product name	APAT Mount System
Application	Flat concrete roof
Inclination	Standard or customized
Material	Aluminum 6005 T5
Finish	Anodized clear, average 12um
PV module	Framed
Module size	Small and Big modules
Module orientation	Portrait
Module direction	South , North

PAT System

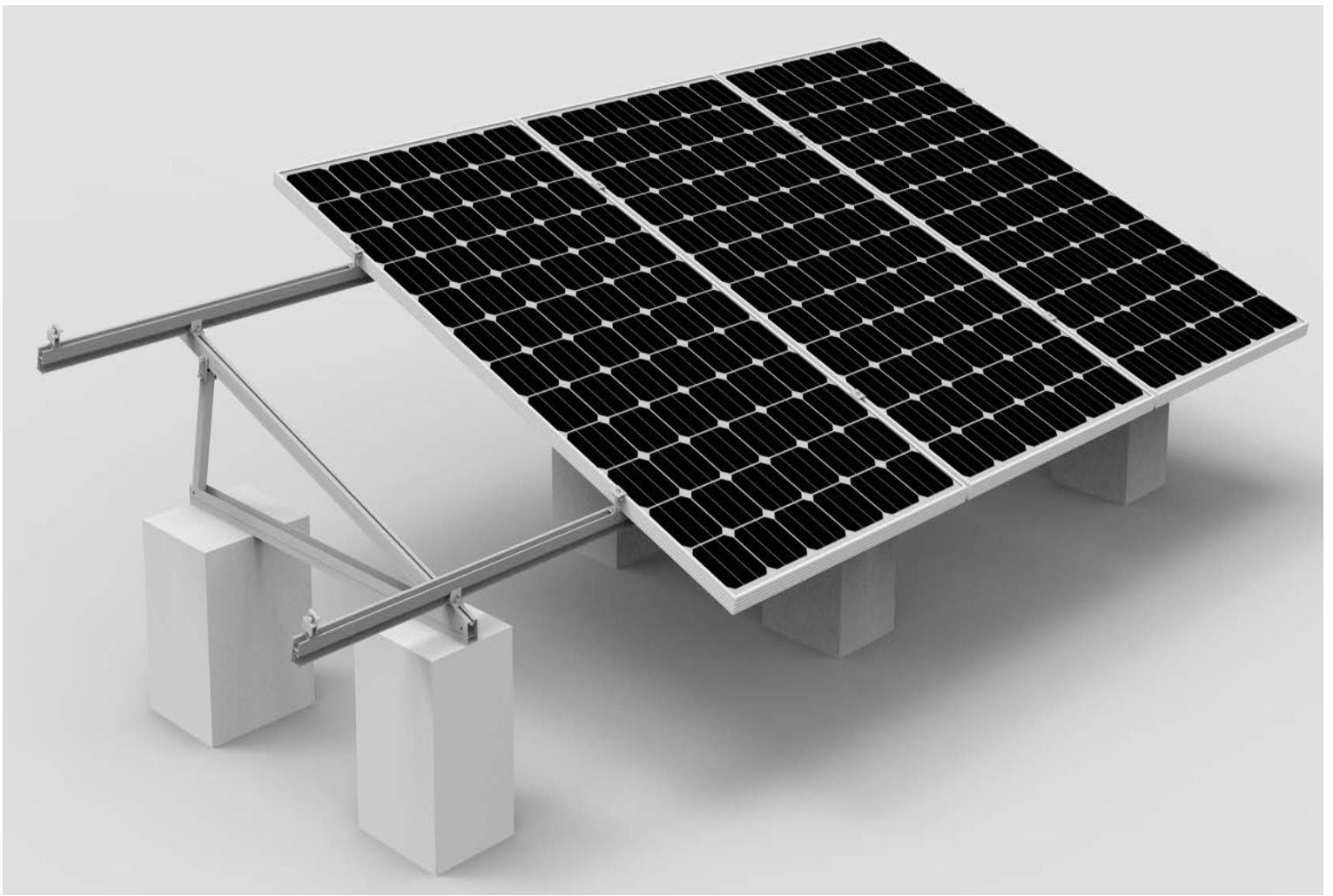

Components



5L Rail



Rail Splice



Mid Clamp



End Clamp



Rail Fix Kit



Expand Bolt



PAT Leg

Advantage

- Unique transfer kit design on PAT legs, stronger support ability
- Pre-assembled PAT legs for easy and quick to install
- Easy and flexibility to used on flat metal sheet roof
- Universal mid and end clamp for 30 to 40 mm thickness modules
- Flexibility for long or short rows arrays

Unique Feature

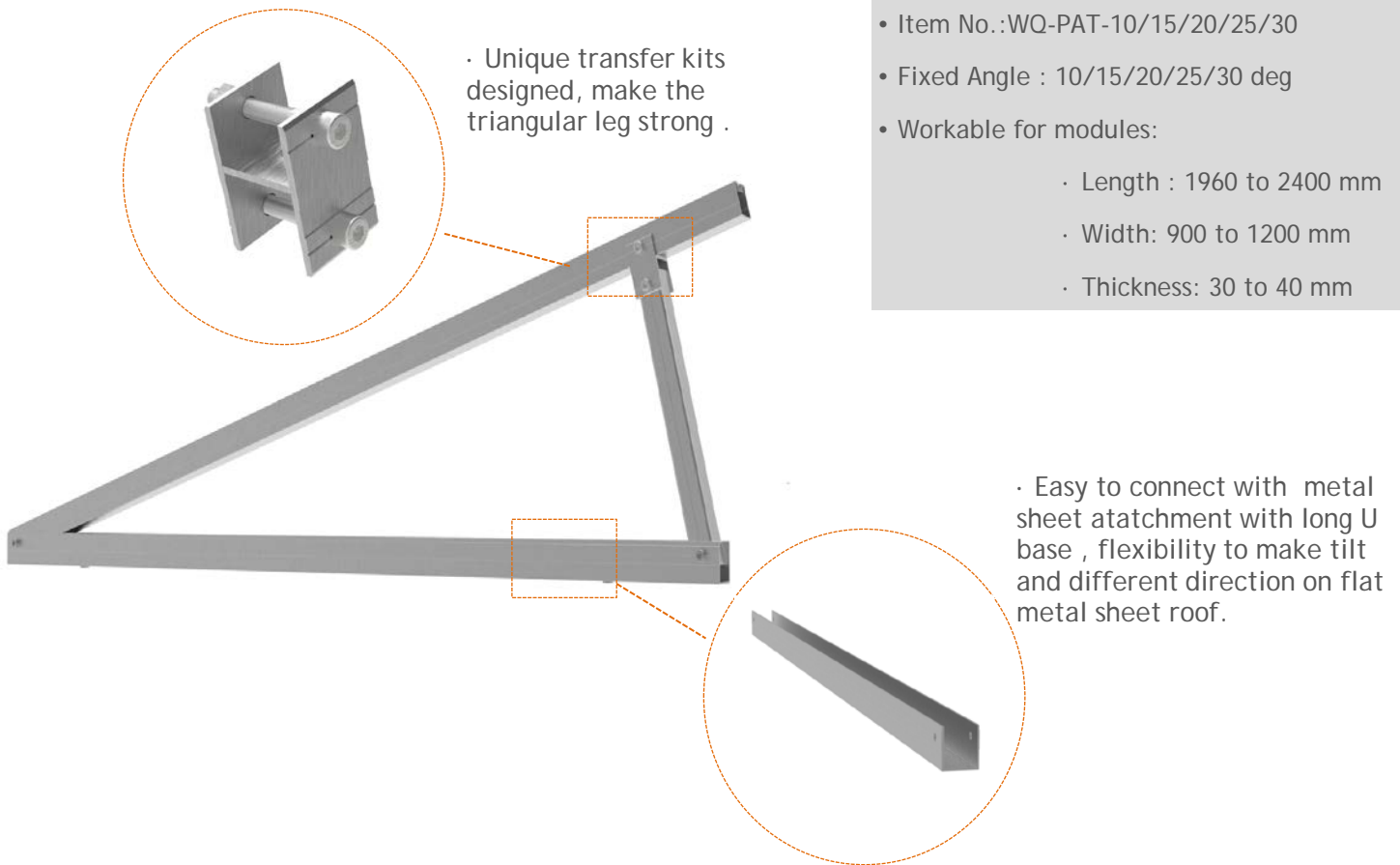

- Item No.:WQ-PAT-10/15/20/25/30
- Fixed Angle : 10/15/20/25/30 deg
- Workable for modules:
 - Length : 1960 to 2400 mm
 - Width: 900 to 1200 mm
 - Thickness: 30 to 40 mm

Technical Data

Product name	APAT Mount System
Application	Flat metal sheet and flat concrete concrete roof
Inclination	Fixed 10/15/20/25/30 deg or customized
Material	Aluminum 6005 T5
Finish	Anodized clear, average 12um
PV module	Framed
Module size	Small and Big modules
Module orientation	Portrait and landscape
Module direction	South , North

ECO N&S System

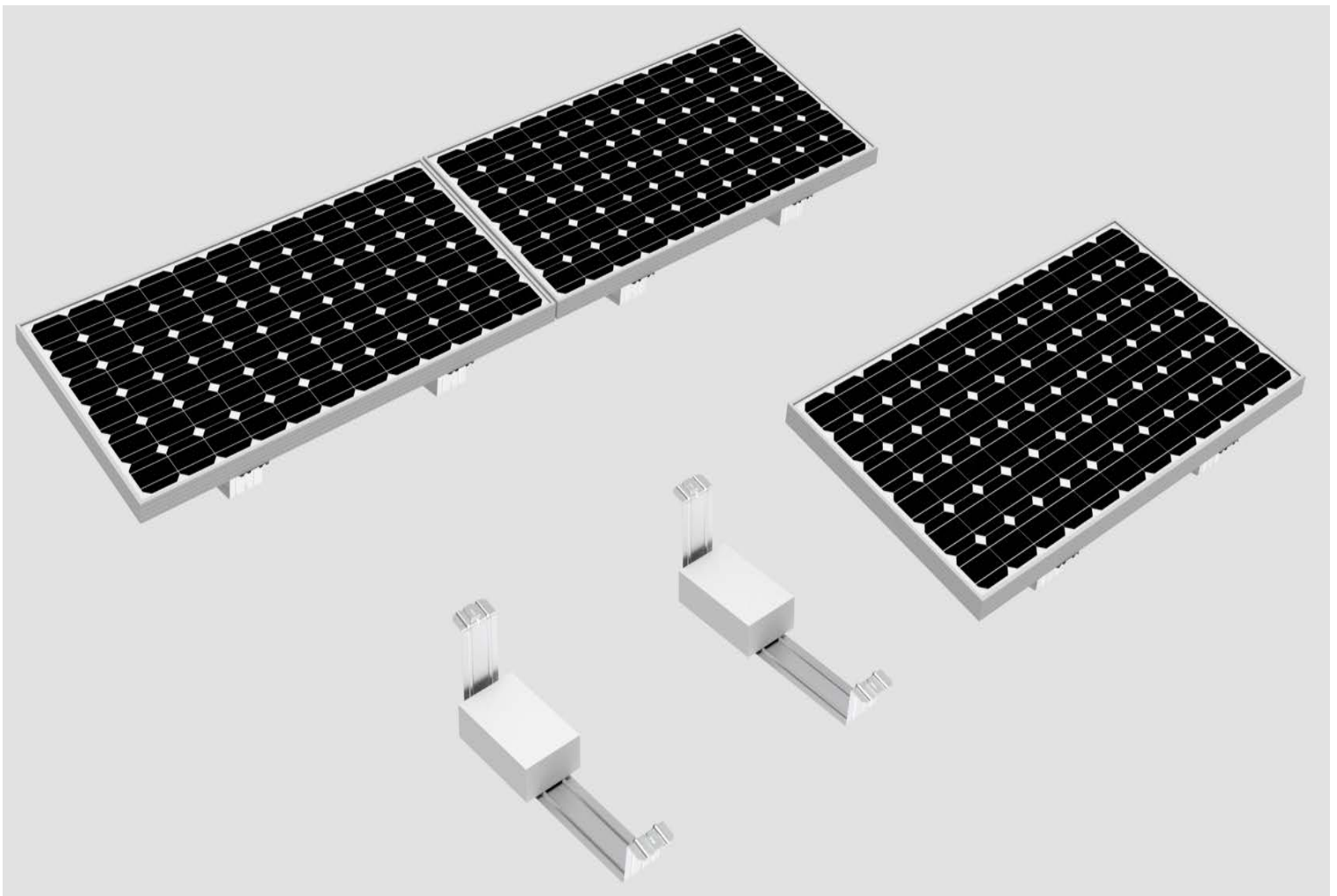

Components



ECO Leg



M6 Hex Bolt

Advantage

- Only two components
- Easy and quick to install
- Best idea for DIY installation
- Use the modules frame hole to fix modules, perfect to protect the modules

Unique Feature



· Easy to fix solar module with frame hole and ECO leg hole, only one M6 bolt could workable !

Item No.	Tilt	Workable Modules
WQ-ECO-1000-10	10	Width:900-1000
WQ-ECO-1000-20	20	Width:900-1000
WQ-ECO-1100-10	10	Width:1050-1200
WQ-ECO-1100-20	20	Width:1050-1200

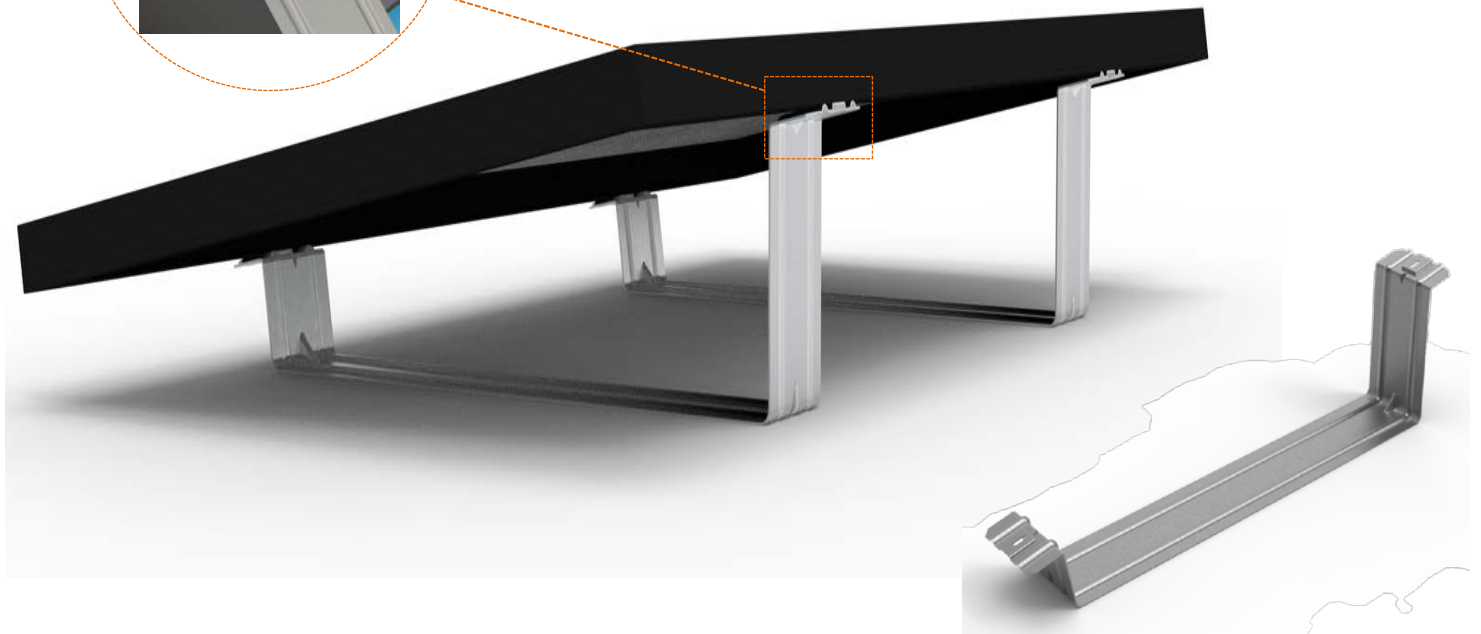

Technical Data

Product name	ECO N/S Mount System
Application	Flat concrete roof
Inclination	10 / 20 /30 deg
Material	Aluminum
Finish	Nature
PV module	Framed
Module size	Small and Big modules
Module orientation	landscape
Module direction	South , North

ECO W/E System

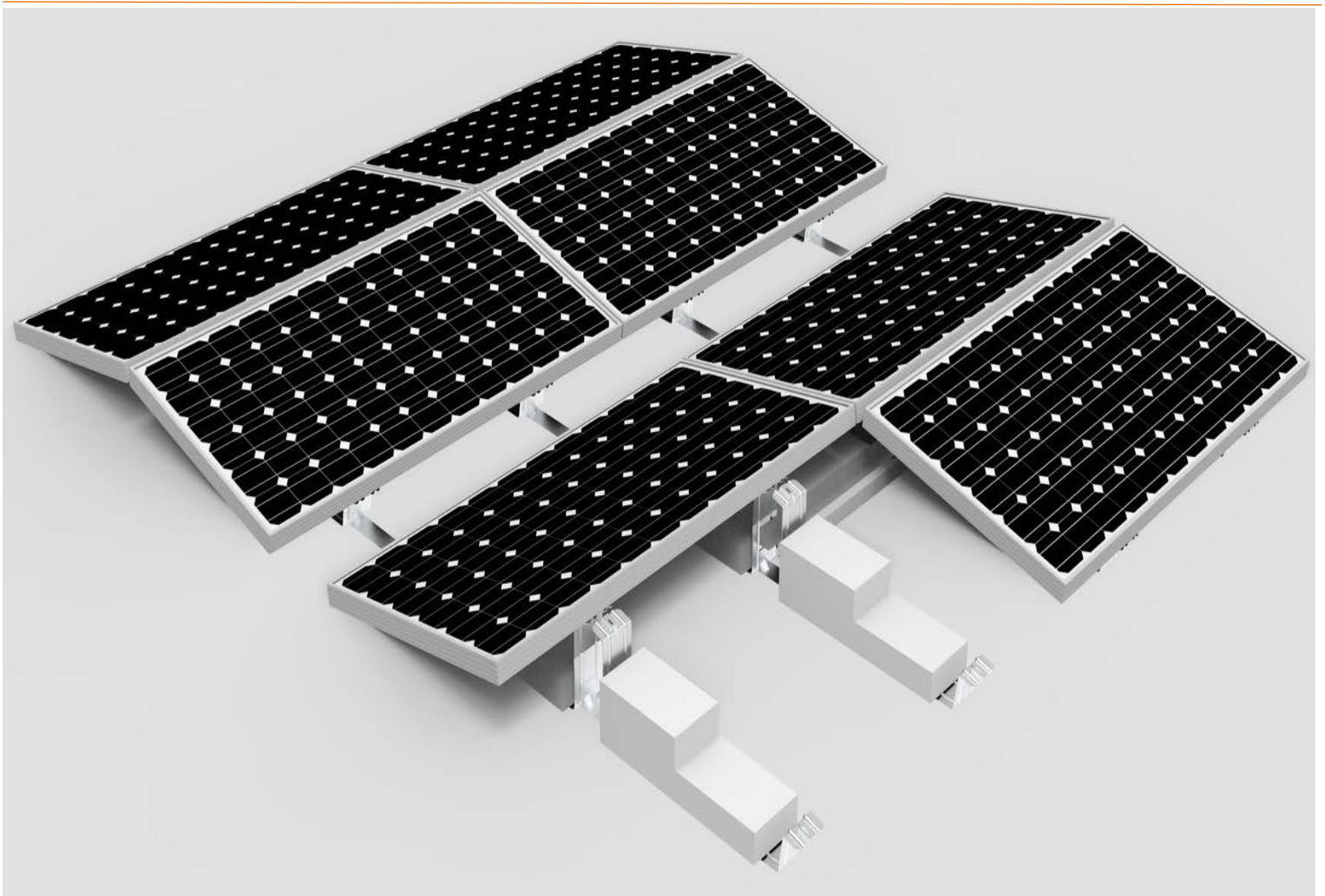

Components



ECO Leg



M6 Hex Bolt



Shot connector



Long connector

Advantage

- East to west installation
- Easy and quick to install
- Best idea for DIY installation
- Use the modules frame hole to fix modules, perfect to protect the modules

Unique Feature

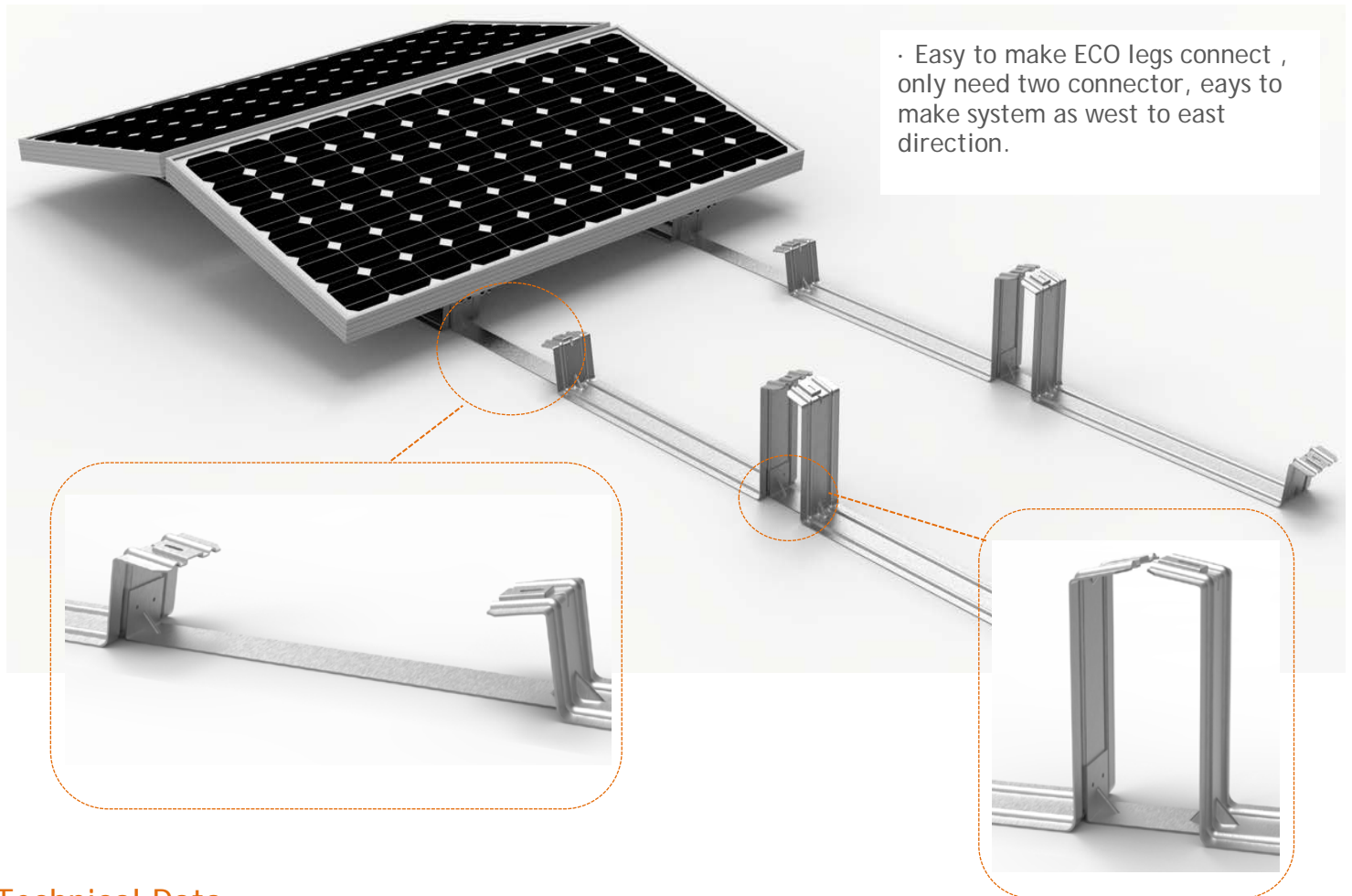

Technical Data

Product name	ECO W/E Mount System
Application	Flat concrete roof
Inclination	10 / 20 /30 deg
Material	Aluminum
Finish	Nature
PV module	Framed
Module size	Small and Big modules
Module orientation	landscape
Module direction	West to East

Arch 5.10 System

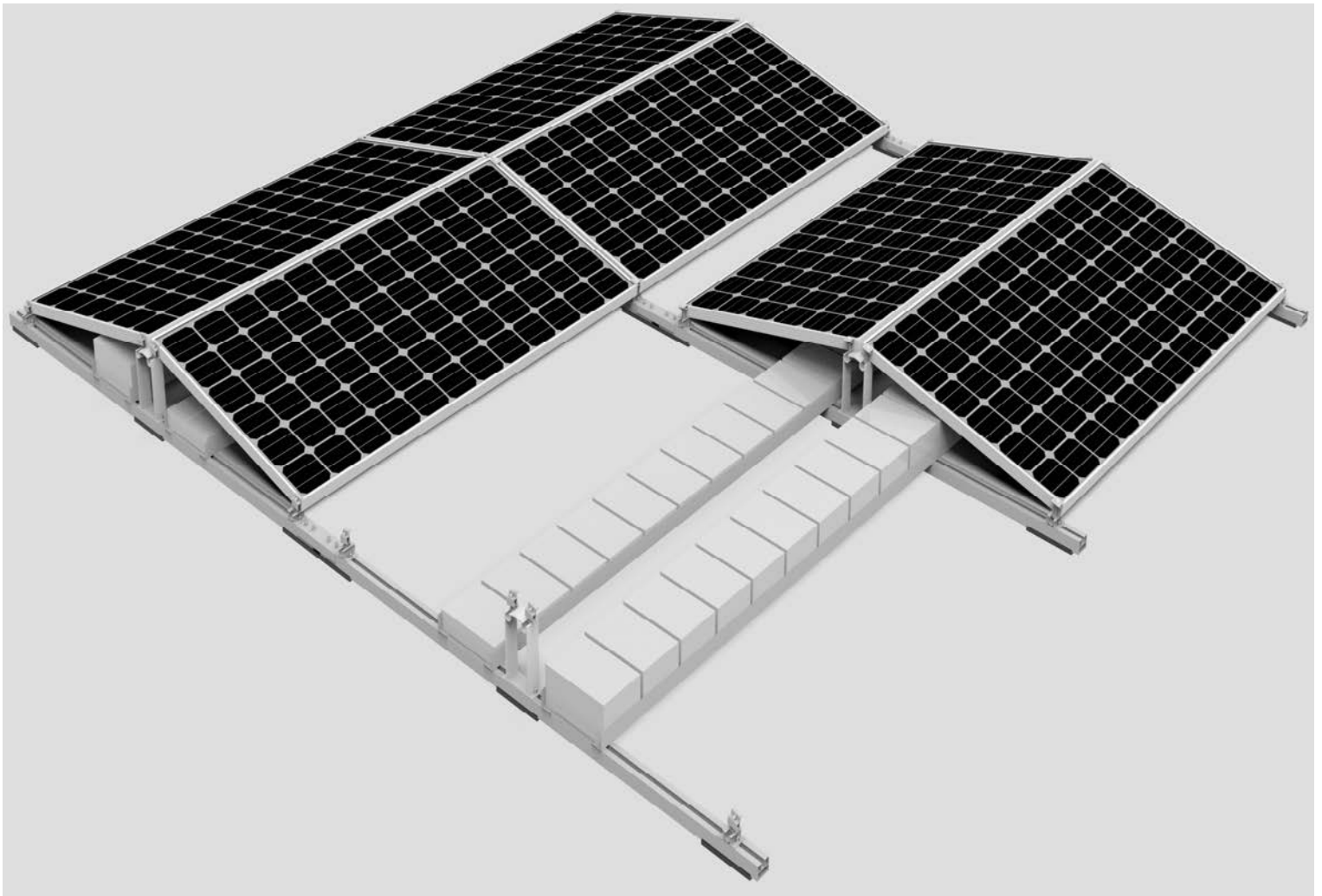

Components



Arch5 Back Leg



Arch5 Front Leg



Arch5 Base beam



Arch5 Base beam connector

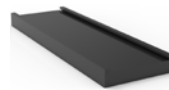

Rubber Pad



Ballast Support Aluminium Angle



Mid/End Clamp

Advantage

- East to west installation
- Easy and quick to install
- Traditional Angle aluminium to palace ballast, weight loading spread each site of roof, protect roof well.
- Strong force loading to load big modules
- Universal mid and end clamp for 30 to 40 mm thickness modules

Unique Feature

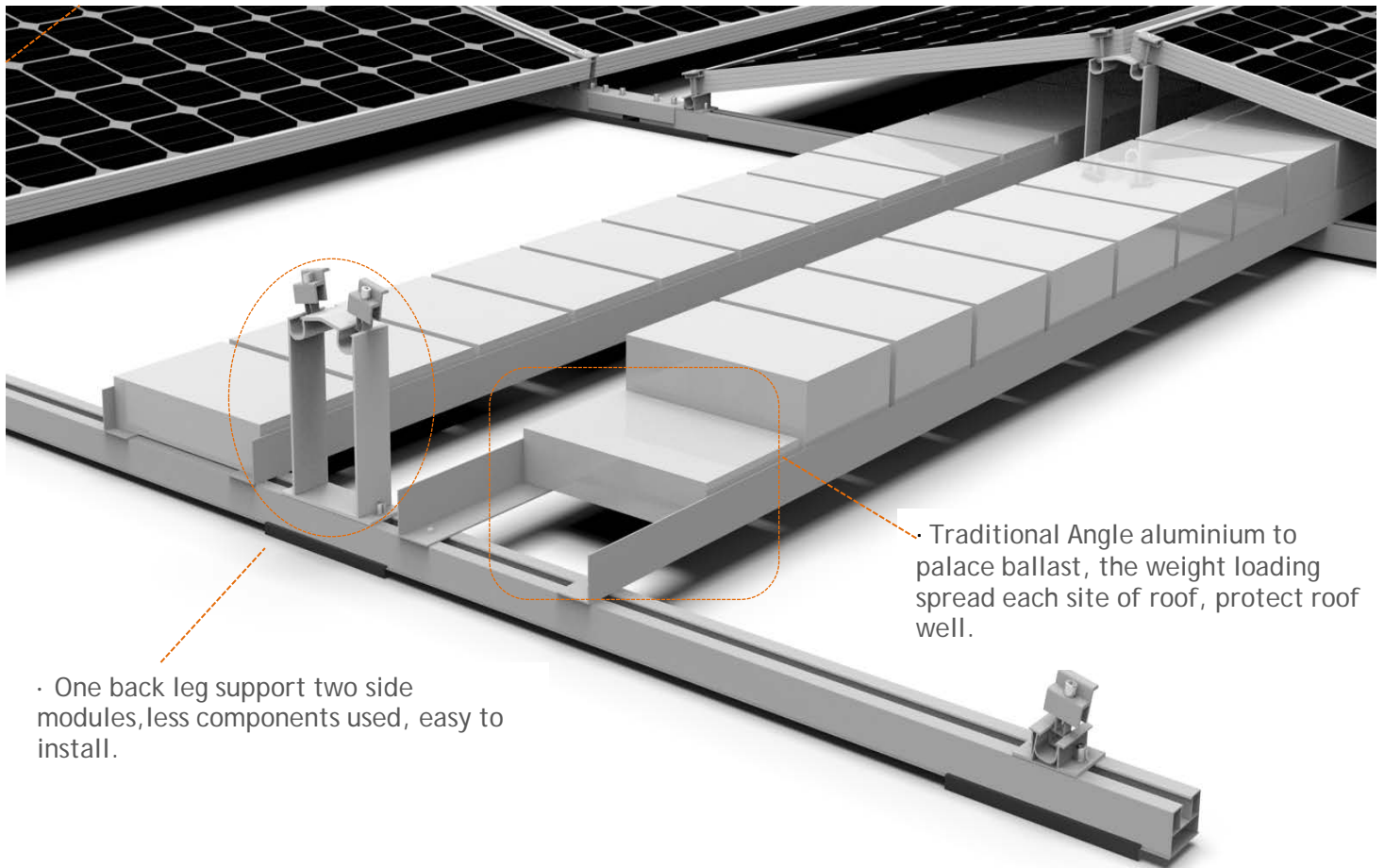

Technical Data

Product name	Arch 5.10 Mount System
Application	Flat TPO/PVC roof
Inclination	10 deg or customized
Material	Aluminum 6005 T5
Finish	Anodized clear, average 12um
PV module	Framed
Module size	Big modules
Module orientation	landscape
Module direction	West to East

Arch 5.20 System

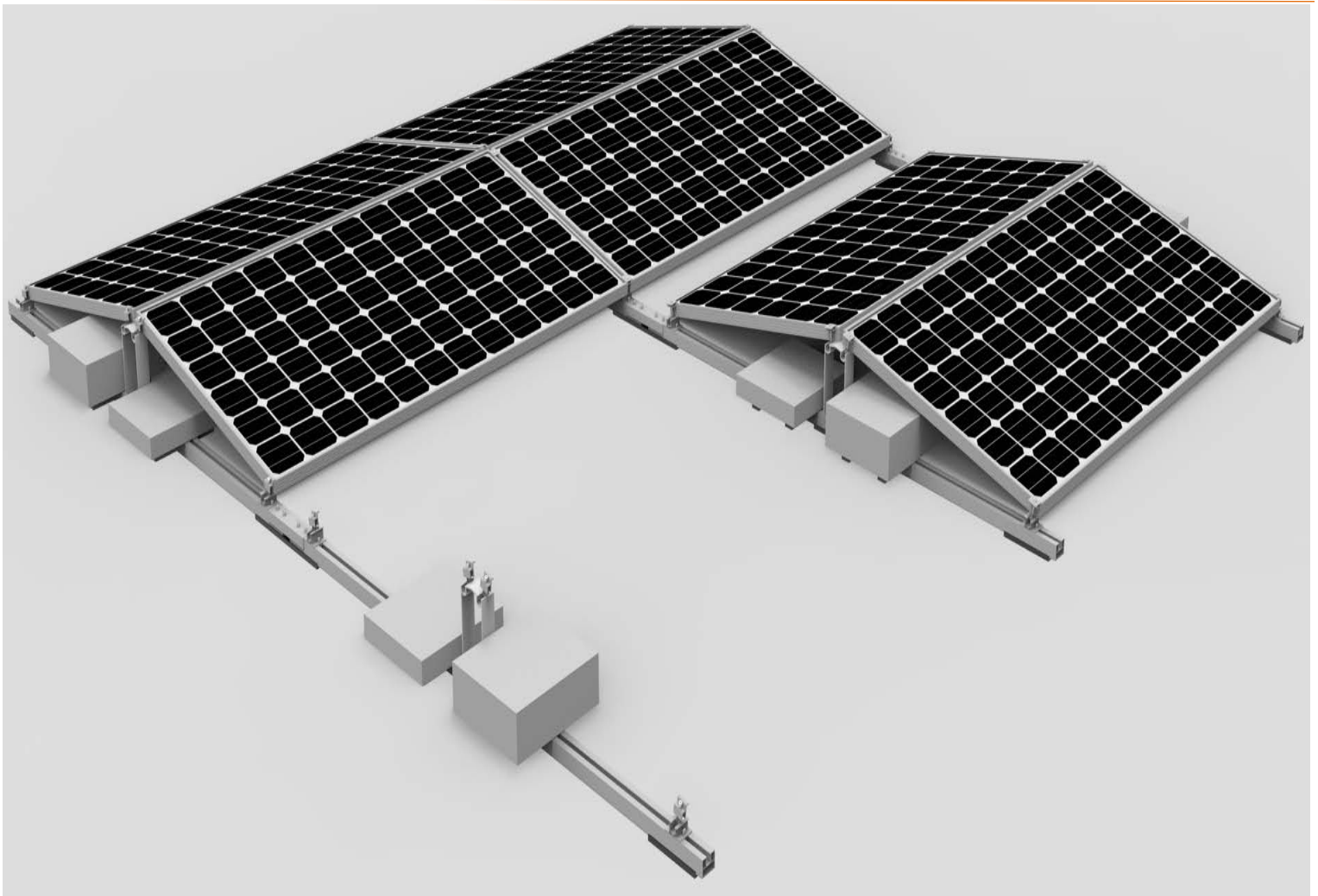

Components



Arch5 Back Leg



Arch5 Front Leg

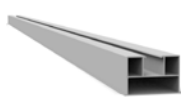

Arch5 Base beam



Arch5 Base beam
connector

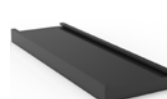

Rubber Pad



Ballast Tray



Mid/End Clamp

Advantage

- East to west installation
- Easy and quick to install
- Fast fix ballast tray on base beam, and very easy to place ballast on the ballast tray
- Strong force loading to load big modules
- Universal mid and end clamp for 30 to 40 mm thickness modules

Unique Feature

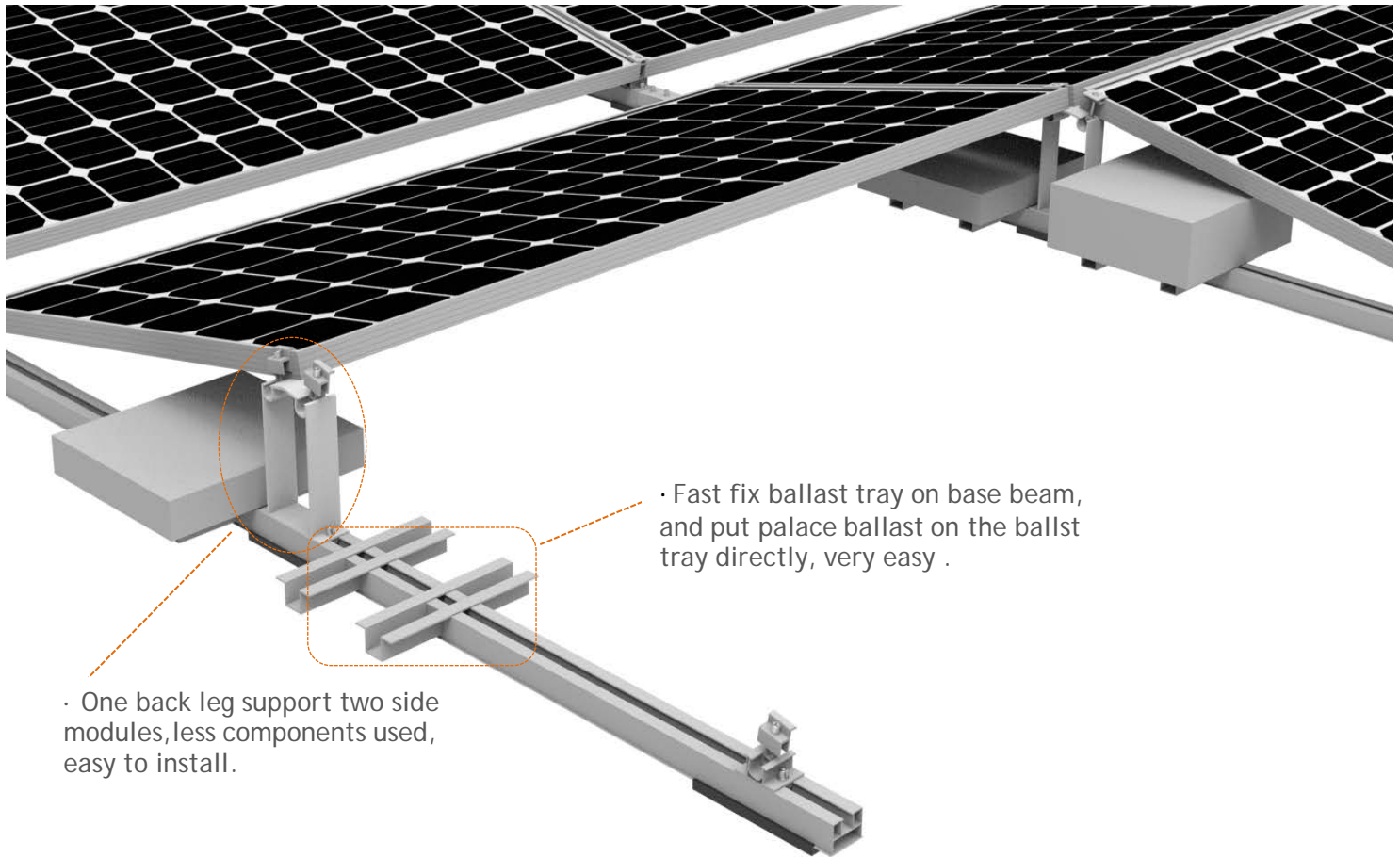

Technical Data

Product name	Arch 5.20 Mount System
Application	Flat TPO/PVC roof
Inclination	10 deg or customized
Material	Aluminum 6005 T5
Finish	Anodized clear, average 12um
PV module	Framed
Module size	Big modules
Module orientation	landscape
Module direction	West to East

Arch 5.30 System



Components



Arch5 Back Leg



Arch5 Front Leg



Arch5 Base beam



Arch5 Base beam connector

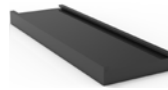

Rubber Pad



Anchor with Rail



Mid/End Clamp

Advantage

- East to west installation
- Easy and quick to install
- Non ballast required, decline the roof weight loading issue
- Strong force loading to load big modules
- Universal mid and end clamp for 30 to 40 mm thickness modules

Unique Feature

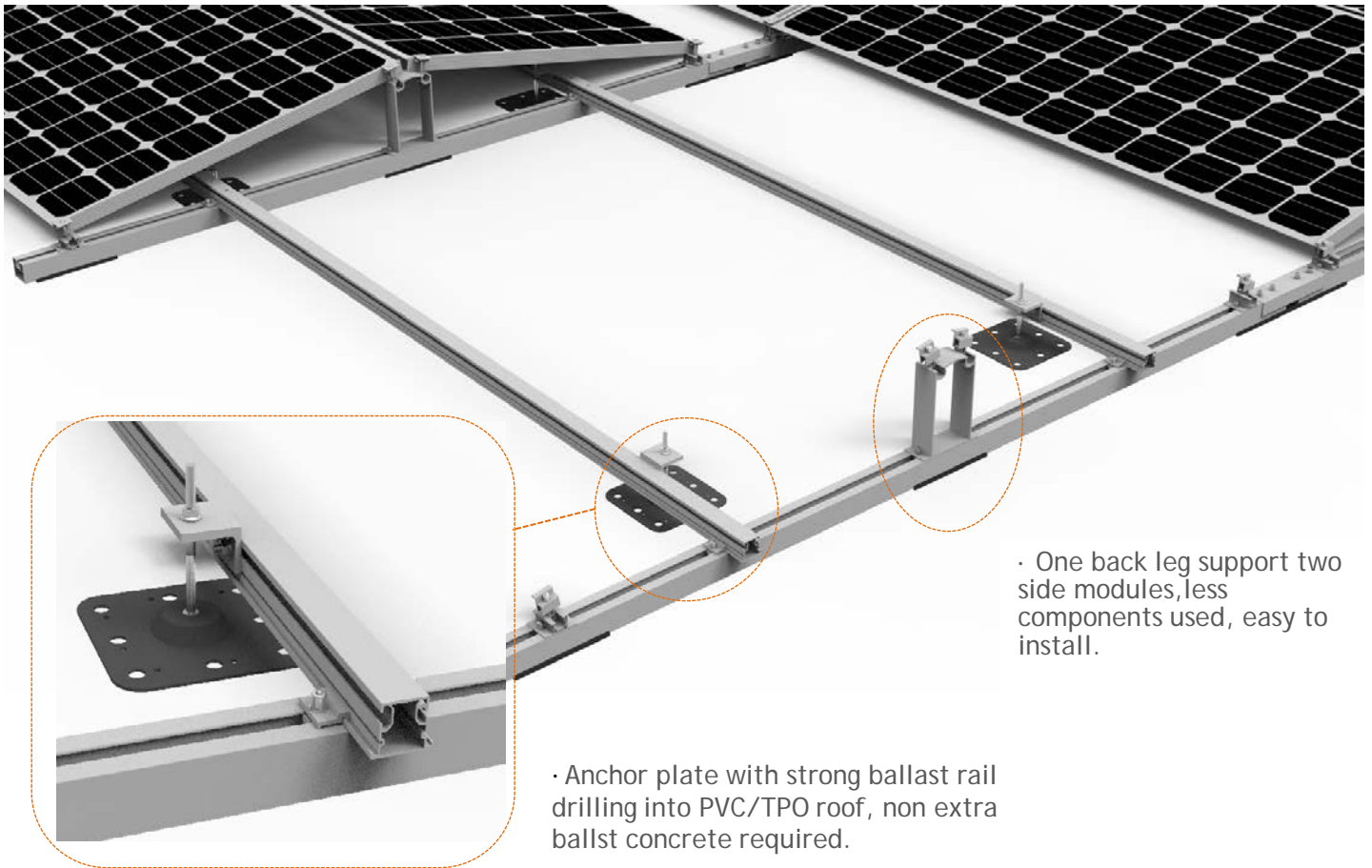

- One back leg support two side modules, less components used, easy to install.

- Anchor plate with strong ballast rail drilling into PVC/TPO roof, non extra ballst concrete required.

Technical Data

Product name	Arch 5.30 Mount System
Application	Flat TPO/PVC roof
Inclination	10 deg or customized
Material	Aluminum 6005 T5
Finish	Anodized clear, average 12um
PV module	Framed
Module size	Big modules
Module orientation	landscape
Module direction	West to East

**Creating the greatest value for you
In worldwide**



Wochn Green Energy Co.,Ltd

Add: Xicen Building 349, Qingpu District, Shanghai,China

Tel: 0086-21-39519802

Mob: 0086-15721481648

Email: sales@wochnmount.com

Web: www.wochnmount.com