

Date Sheet & Brochure

WOCHN Standing seam clamp AC-03A is rail-less system specifically made for Lysaght Klip-lok 406 metal seam roofing. No rail requirements. Pre-assembled side-bolts for super quick install. The clamp maintains the elegance of your standing seam metal roof with no harm to the roof material. Installation is as simple as placing the clamp on the seam and tightening the setscrew to the specified tension to reach maximum holding strength.

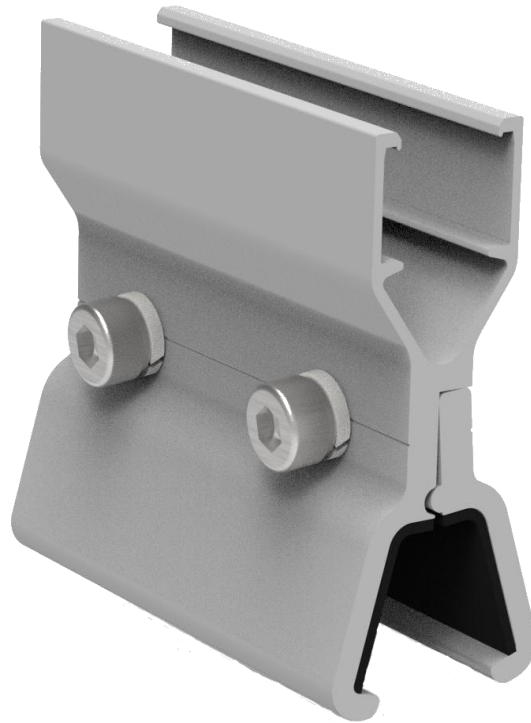

Standing seam clamp
Item:WQ-AC-03A

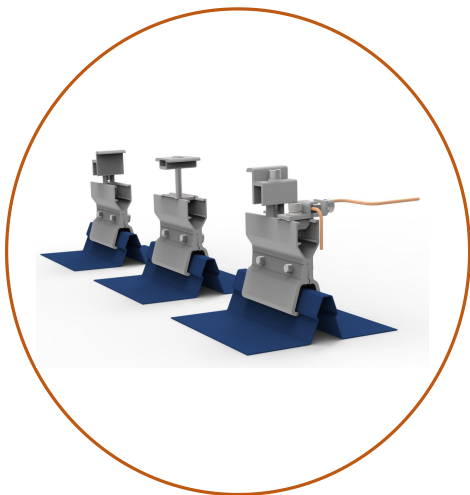

Rail-less

No rail requirements, universal components are easy to install.

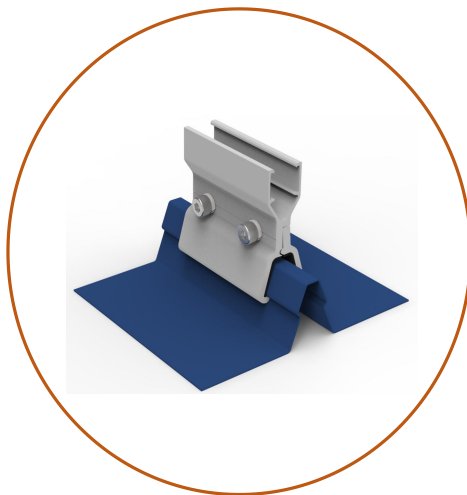

Water-proof

No penetrative means no water leak on the roof.

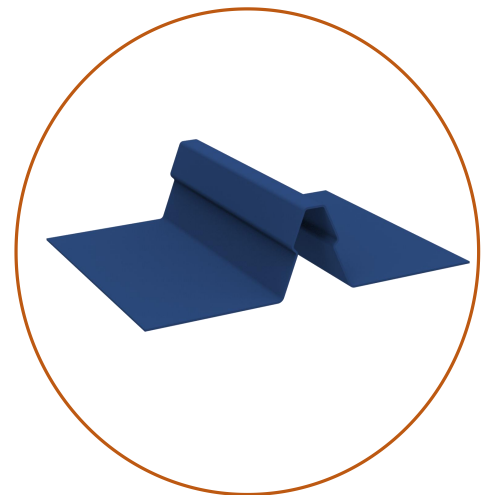

Workable seam

Suitable for Lysaght Klip-lok 406 metal seam roofing.

Technical Data

Max pull out load vertical to roof:	7.8KN
Screw tension:	up to 4NM
Ultimate Tensile Strength:	62
Tensile Yield Strength:	42
Fatigue Strength:	100 Mpa
Shear Modulus:	26.0 Gpa
Shear Strength:	205 Mpa
Hardness, Knoop:	21
Hardness, Vickers:	701
Elongation at Break:	0.80%
Modulus of Elasticity:	69.0 Ga

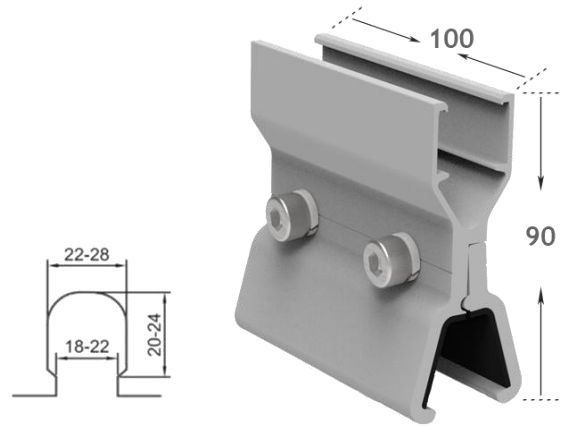

Unit: mm

Quick Installation Guide



Step 1:
Confirm the Lysaght Klip-lok 406 metal seam roofing and clamp position.

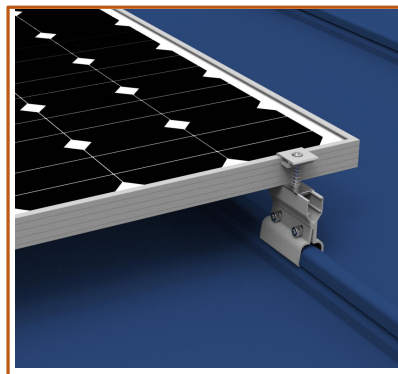

Step 2:
Put the mid clamp on Clamp.

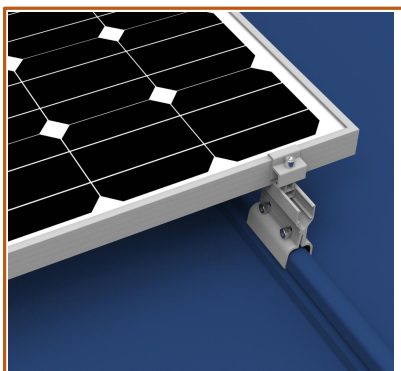

Step 3:
Put the end clamp on Clamp.

Torque value:
12 N.m



Step 4:
Put the module on clamp and fasten.

Torque value:
12 N.m